

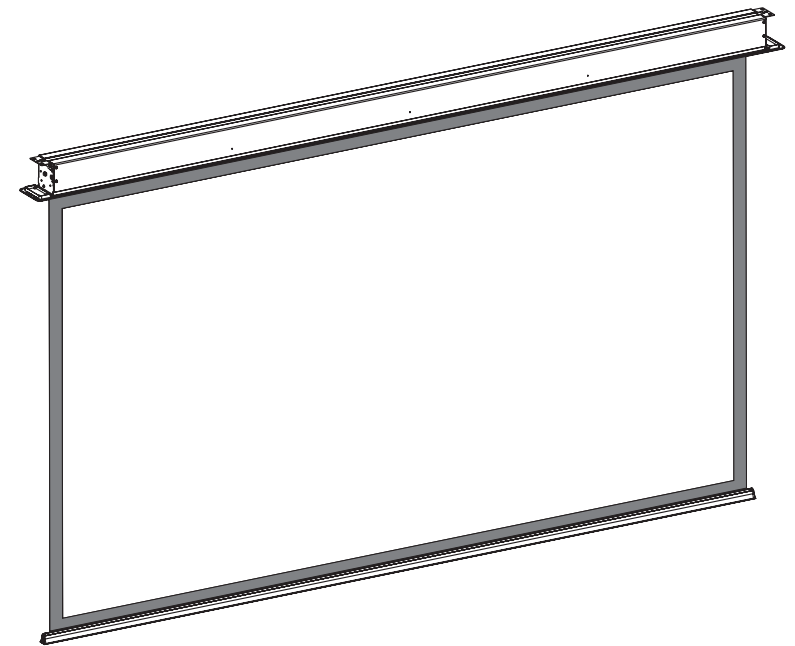

Instruction Manual of Mini Recessed Motorized Screen



Model: SESC

Technical Assistance

If you need help with installing this screen please visit
www.sapphireav.com























Thank you for purchasing a Sapphire projection screen.

Before use, please read instructions carefully. After installation, store instructions for future reference.

Warnings

Please read the below attention points before using

1.   Please hand over the screen to qualified professional for installation, non-qualified individual could cause damage to the product or injury of people.
2.   Please make sure that the installation position can suffer from at least 50 Kg, otherwise there could be a potential dropping problem causing damage to the product or injury of people.
3.   It is forbidden to connect the power before the installation is finished, otherwise it could cause damage to the product or injury of people.
4.   Wrong wiring or malfunction of the wire could cause damage to the product or inquiry of people, please hand over the electric work to electric professionals.
5.  The product is using Single-phase AC power, please use a socket with earth wire and make sure the earth wire is well connected.
6.  Please make sure the screen is installed in a level status, otherwise it could cause damage to the product.
7.  For screen with IR control, please do not use it in places with strong light or laser. For screen with remote control, please do not get close to fluorescent lamp, led lamp or other device or environment with strong electromagnetic radiation, to avoid damage to the product.
8.  In order to lower down the possibility of fire or electric shock, please do not expose the product in damp places.
9. Please keep the screen away from heating device such as heater, stove, etc.
10.   As long as the plug is still in socket, the screen is still connected with AC power, please remove the plug during lightening, thunderstorm or not used for extended periods.
11.  Please retract the fabric fully in the case after using to avoid damage to the fabric by dust and dirt.
12.  If the surface of fabric is dirty or being cut, it will affect the image quality, so please pay attention to below points:
 - A. Please do not touch the fabric with your hand
 - B. Please do not write or draw on the fabric
 - C. Please do not cut or poke the fabric to avoid damages
 - D. Please do not clean the surface with chemical cleaner, you can use dry cloth and soap water instead.
13.  To avoid unnecessary damage, please use and manage the product by adult.
14.  Please choose only the accessories from original factory.
15.   Please do not hang any items under the case to avoid potential damages.
16. There are no spare parts inside for replace or repair, please contact the after sales team for after sales service.
17. Lubricant is not required for the motor.



Ignoring the safety warnings may lead to injuries and/or damaging the product.



Fixtures should be installed in a secure place to avoid accidents or the screen falling.



Do not connect any electrical attachments or remote controls.



Roll up the screen after every use. Leaving it hanging for a long period of time may cause the fabric to loosen.



Please contact your local dealer for repairs or maintenance. Please contact our company if you have any further questions. Avoid taking apart the fixtures yourself. Loose parts may cause the screen to fall.



Refrain from hanging anything on the screen as it may cause the screen to fall.

Accessories Pack(s)

- Left Decoration cap*1 pcs (with control panel)

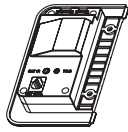

- Right Decoration cap*1 pcs

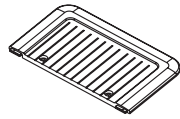

- M5*10 Cup head machine screw with cover (4 pcs respectively)



- Ceiling bracket*2 pcs



- M5*10 thumb head screw*4 pcs
- M4 hexagonal adjuster key*1 pc



- IR remote control emitter*1 pc

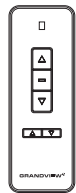

- Power cable with plug* 1 pc

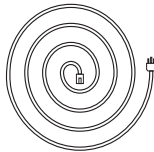

- Qualification certificate*1 copy

- Manual*1 set

- Warranty card* 1 set

- M8*500 extended bolt*2 pcs



- M8 nut*8 pcs, gasket*8 pcs



- Φ8 Spring gasket*6 pcs



- M8*60 expansion screw(4 pcs)

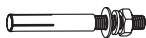

- Hook*2pcs

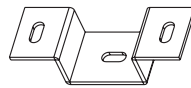

- 12V trigger wire*1 pcs



Optional Accessories

- Wall switch*1 pcs (low voltage dry contact control)



- EXT IR receiver*1 pcs



- RF power-sync emitter and RF converted to IR receiver*1 set

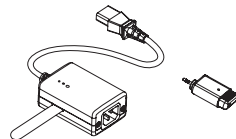

Adjustment

Instruction of adjusting the retraction and extension limit

1. The default retraction limits are perfect settings, we do not recommend adjustment to avoid potential damage to the product, please talk to after sales team for further advice.

2. If you do need adjust the extension limit, you can do that through the slot underneath the right hand side of the screen, with below instructions:

WARNING

Please pay attention when adjusting retraction. Over-retraction is avoided in order not to spoil the motor and screen; please also pay attention when adjusting extension. The fabric should be rolled at least one and a half rounds onto the shaft to avoid the fabric fall off. After the adjustment is done, the difference of retraction and extension limit might not be found at once until the screen is operated for several times.

Adjustment of extension (lower limit).

Press the "down" button of the controller and the screen would extend. Insert the adjuster key into the positioner adjusting hole in yellow color on motor to make adjustment. Stand opposite to positioner adjusting hole and turn adjuster key clockwise to make fabric retract slightly, while turn counter clockwise to make fabric a little extension for adjustment.

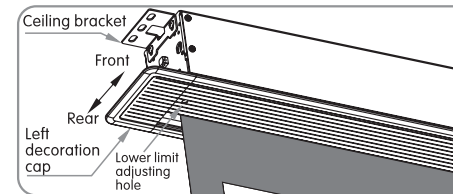

Diagram 32

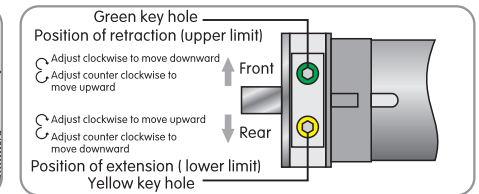

Diagram 33

Due to the special structure of the product, default of "retraction limit" has been perfectly set and it is not recommended to make adjustment by user so as not to damage the screen because of improper adjustment on retraction limit. Any damage out of this operation is not under warranty for the product.

Adjustment of retraction (upper limit).

Press the "up" button of the controller and the screen would retract. When the fabric rod goes nearby or enters the case, please insert the adjuster key (slight adjustment on direction is needed when insert adjuster key until the key enter correctly into the green hole) into the positioner adjusting hole in green color on motor to make adjustment. Stand opposite to positioner adjusting hole and turn adjuster key clockwise to make fabric extend slightly, while turn counter clockwise to make fabric a little retraction for adjustment.

Note on upper limit adjustment:

The decoration board of this product can completely cover the exit of the case and there is springs installed on the integration of fabric rod, which is different from other series of screens.

When adjusting the upper limit, please make sure decoration board could be completely closed. Enough space is needed for decoration board to move freely. Setting the upper limit to be too high would come to damage the fabric or motor.

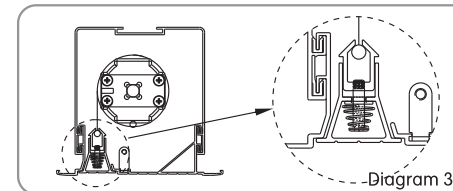
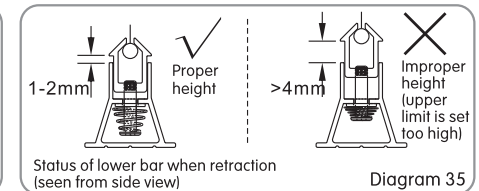

Diagram 34



Status of lower bar when retraction (seen from side view)

Diagram 35

Operation instruction

2. Manual control

Manual control button is available in case the remote controller is not at hands. The manual button is located below the left end cap. (see diagram 34). By pressing the manual button, screen would circle the operation of extension-stop-retraction.

External control (dry contact or RS232, wall switch)

Connect the crystal head of signal wire into EXT CTRL on left end cap of screen, and the other end of signal wire would be connected to central control application, computer RS232 port or switch (see diagram 35-39) to control the screen. See diagram 35 for control port of the screen. See diagram 36 for connection of signal wire with crystal head.

3. See diagram 37 for control for low voltage dry contact.

4. Control with RS-232/485 port

See diagram 38 for connection of signal wire between EXT CTRL and computer or central control application of RS232/485 port. Screen could be controlled by sending corresponding commands. See diagram 39 for port setting and commands.

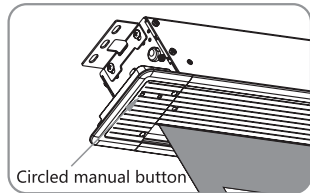

Diagram 34

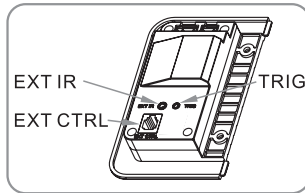

Diagram 35

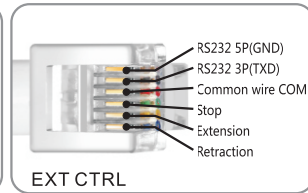

Diagram 36

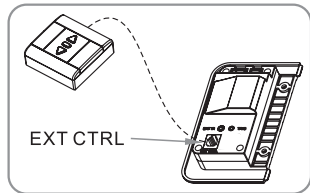

Diagram 37

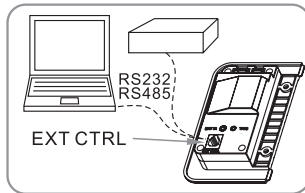

Diagram 38

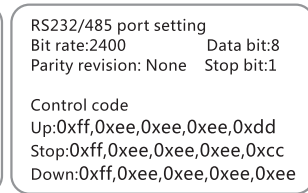

Diagram 39

5. Control with 12V trigger wire

Connect the trigger wire (optional accessory) to the "TRIG" hole on left end cap of screen with one end, insert the other end into 12V output hole on projector, see diagram 40; screen would extends when projector is turned on, while screen would retract when projector is turned off.

Note: Read user manual for projector in advance to make sure there is 12V output signal from projector.

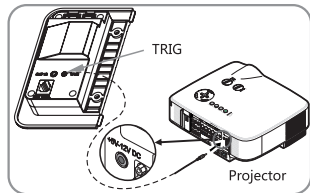

Diagram 40

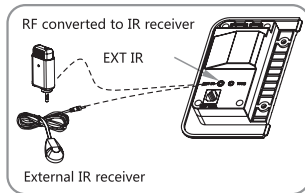

Diagram 41

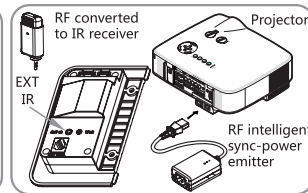
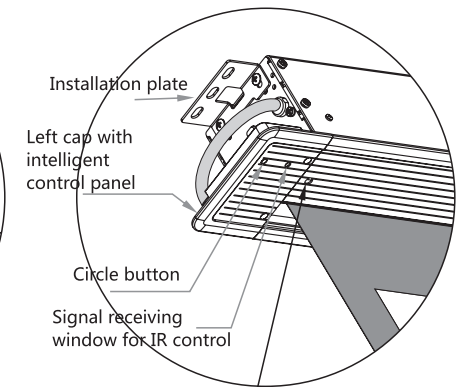
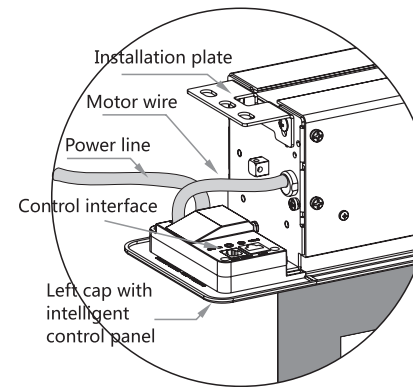
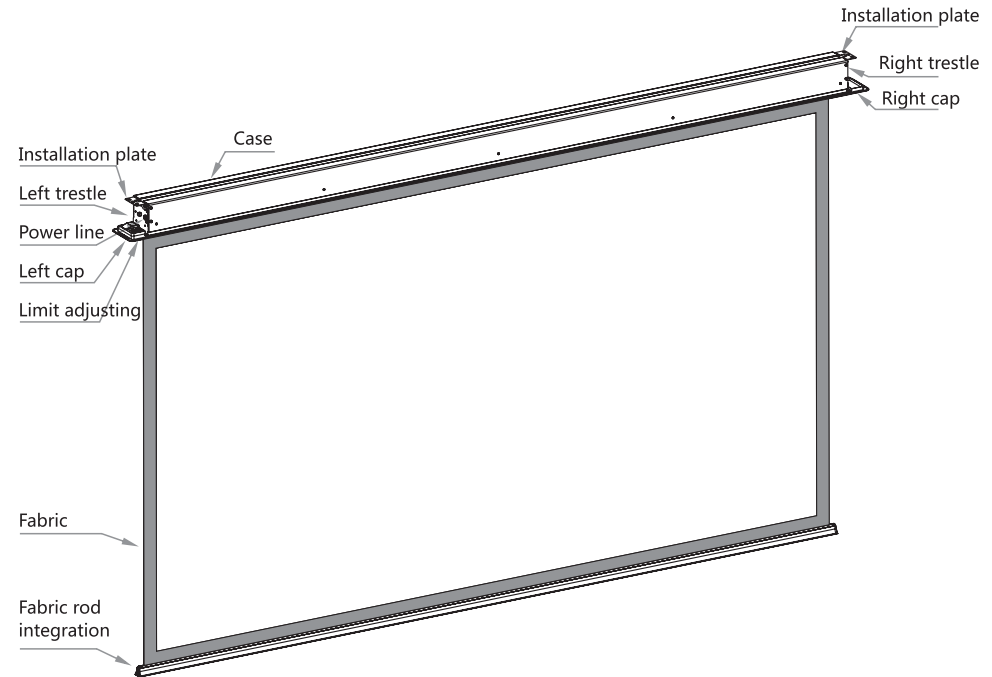
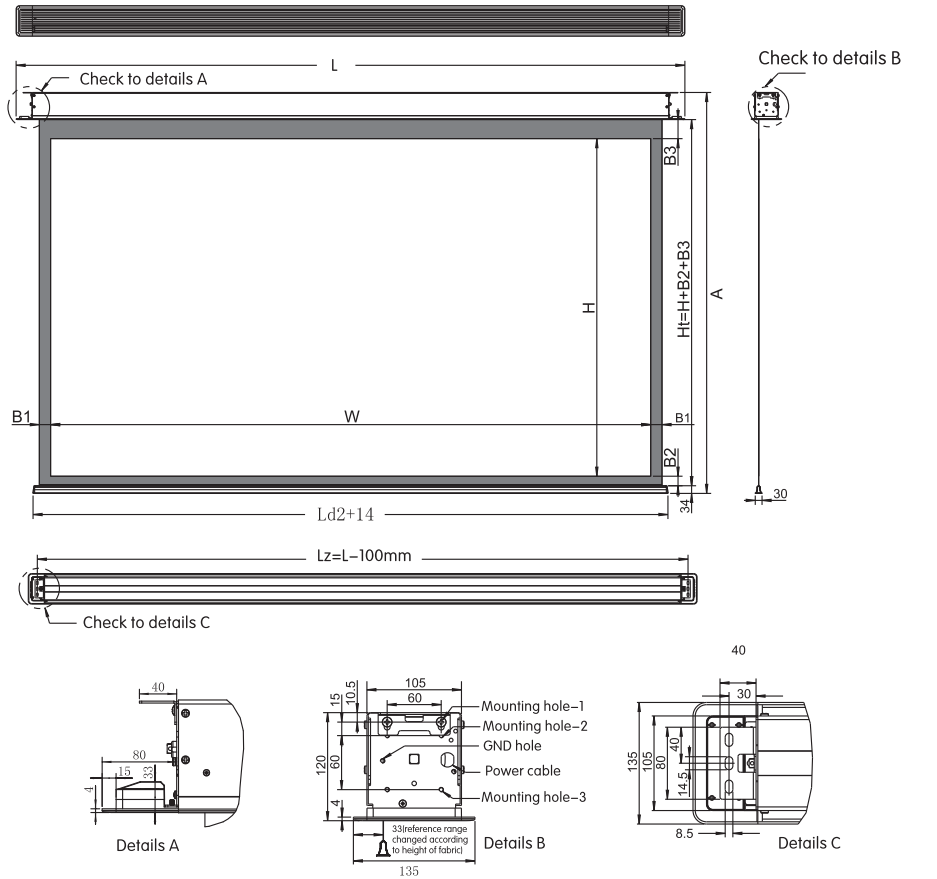

Diagram 42

Operation Instruction



Framework and Dimension



		Inceiling integrated motorized screen													
		Lz=overall length(L)-100mm													
		*Ceiling Cutout dimension: Lt = overall length(L)-20; Cutout width: 115mm; height >122mm;													
		4:3				16:9				16:10					
Variant	Ratio	SESC xxx BV-A2			SESC xxx BWSF-A2			SESC xxx B1610-A2							
		180	200	240	300	180	200	240	270	300	180	200	240	270	300
Parameter name	Diagonal	84"	100"	120"	150"	77"	92"	106"	120"	138"					
Width of viewing area	W	1707	2032	2438	3048	1705	2032	2346	2656	3048	1705	2032	2346	2656	3048
Height of viewing area	H	1280	1524	1829	2286	959	1146	1320	1494	1715	1066	1270	1466	1660	1905
Left and right black border	B1	50	50	50	50	50	50	50	50	50	50	50	50	50	50
Bottom black border	B2	30	30	30	30	30	30	30	30	30	30	30	30	30	30
Top black border	B3	670	420	120	80	990	800	630	450	651	883	676	484	284	461
Canvas overall height	Ht	1980	1974	1979	2396	1979	1976	1980	1974	2396	1979	1976	1980	1974	2396
Length of bottom bar	Ld2	1847	2172	2578	3178	1845	2172	2498	2796	3178	1845	2172	2498	2796	3178
Overall Length	L	2027	2352	2758	3358	2025	2352	2666	2976	3358	2025	2352	2666	2976	3358
Overall height	A	2133	2127	2132	2549	2132	2129	2133	2127	2549	2132	2129	2133	2127	2549
Ceiling cutout length	L1	2007	2332	2738	3338	2005	2332	2646	2956	3338	2005	2332	2646	2956	3338
Installation distance	Lz	1927	2252	2658	3258	1925	2252	2566	2876	3258	1925	2252	2566	2876	3258
Packaging length	Lh	2087	2412	2818	3418	2085	2412	2726	3036	3418	2085	2412	2726	3036	3418
Gross weight (kg)	GW:	13.37	15.45	18.05	21.89	13.35	15.45	17.46	19.44	21.89	13.35	15.45	17.46	19.44	21.89

Electrical data: AC220-230V/50-60Hz, 0.48A, 115W.

Any change on function, structure or specification is without prior notice due to improvements on the product.

Please refer to the specific product included.

Operation instruction

Multi-control systems are available for your optional accordingly

- IR remote control
- Manual control
- Dry contact control with wall switch
- RS-232/485 port
- 12V trigger wire
- External IR or RF converted to IR control
- Control with IP address (only available for IP control model)

1, IR remote control:

AC-127 model of IR controller:

Controller button instruction

- 1.To raise screen press "UP".
- 2.To hold screen at desired position press "STOP".
- 3.To lower screen press "DOWN".
- 4.To raise the screen in smaller increments press ?Micro-Up?
5. To lower the screen in smaller increments press ?Micro-Down?

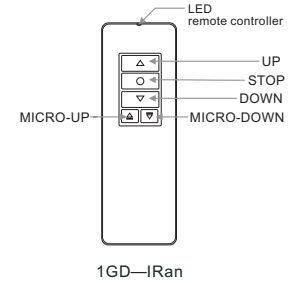

Please Note:

- 1.The shortest distance between receiver and controller is 0.5 meter.
- 2.The remote control will work within 8 meters from the receiver and within a 30 degree radius from the center of the receiver.
- 3.The remote control will not work if the receiver is covered
- 4.Keep the remote control away from high temperature and high humidity areas.
- 5.The batteries will need to be changed when the signal is weak.
- 6.If the remote control is not being used for an extended period of time, please remove the battery.
- 7.Only use batteries intended for the remote control unit.

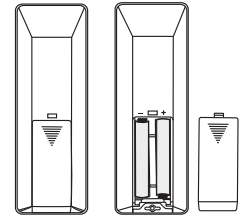

Battery Installation:

- 1.On the back of the remote control, push down to open the cover as shown in the picture.
- 2.Put the battery in according to the correct cathode and anode.
- 3.Close the cover.

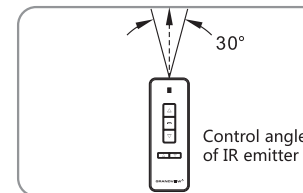

Diagram 31

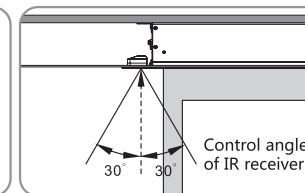

Diagram 32

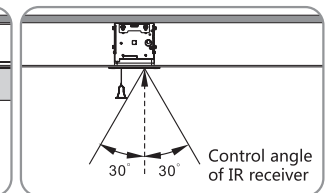

Diagram 33

Installation Instruction

9. Power connect: connect the motor wire on the left hand side of screen to motor end on left end cap, then connect one end of the power cable to the AC IN and the other end to the AC socket, make sure they are connected firmly, see diagram 19-21.

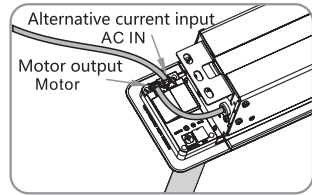

Diagram 19

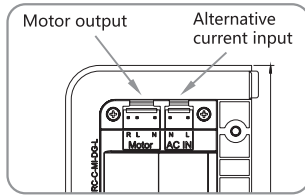

Diagram 20

Corresponding socket	terminal	Wiring instruction	Color for motor wiring	
			230V	120V
AC IN	L	Power phase line		
	N	Power null line		
Motor	N	Motor null line	Blue	White
	L	Motor down	Brown	Red
	R	Motor up	Black	Black

Diagram 21

10. Plug in screen and try not to touch anywhere with high voltage during operation such as AC IN end or Motor end. Press circled manual button on left end cap for several times to operate screen up and down for once or twice. If everything goes alright, please unplug the screen for the next step.

11. To install the left and right decoration cap, please kindly insert the legs (see diagram 23) aslant into slots of front and rear decoration board on the left and right end of screen (see diagram 24). Then push upwards lightly (see diagram 25) and fix the decoration cap firmly onto the bracket with M4*10 machine screws and screw cover. (see diagram 26-27).

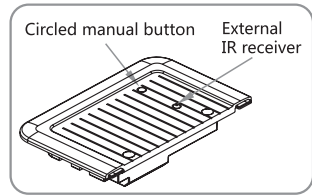

Diagram 22

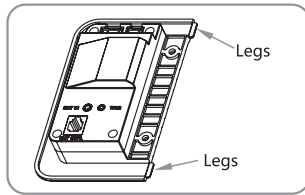

Diagram 23

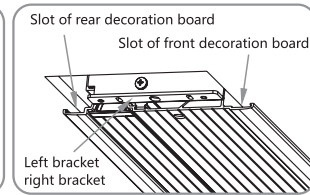

Diagram 24

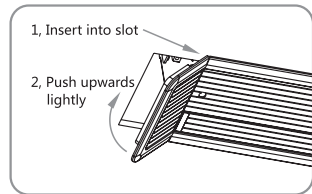

Diagram 25

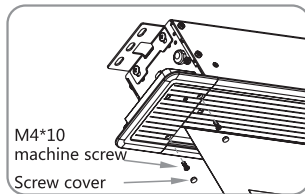

Diagram 26

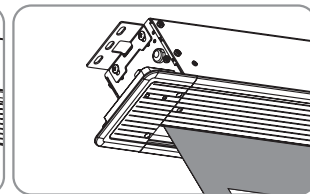

Diagram 27

Note:
Kindly distinguish left and right decoration caps by lines pattern. If installed correctly, the lines pattern on decoration caps should align with lines pattern on front and rear decoration boards. (see Diagram 28-30)
If there is apparent gaps appear, kindly push decoration caps towards till it reaches the end. (see diagram 30)

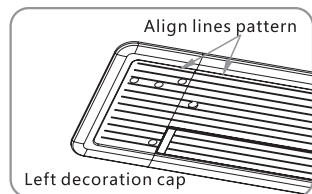

Diagram 28

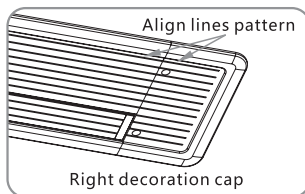

Diagram 29

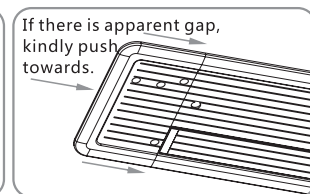

Diagram 30

Installation Instruction

This product is fit to install into all types of decoration ceilings. User could install the product according to different environments. The screen should be installed at the most proper place where it can work with projector. It is more convenient and safer for use when the screen is installed right and correctly.

Please unpack the packages and check if the fittings are correct in number and types. Please install the screen at proper place according to the installation instructions below.

1. Ceiling-cutting should be done at the position where the screen would be installed (diagram 1). The dimension of ceiling-cutting is 115mm in width, while it is 20mm shorter than the overall length. As to the grille ceiling, please take some pieces out of the ceiling (diagram 2) and cut them into pieces that would fit to the ceiling for re-installation after installation of the screen is finished.

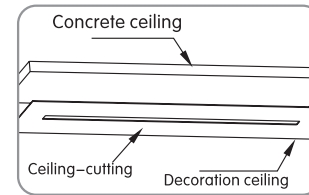

Diagram 1

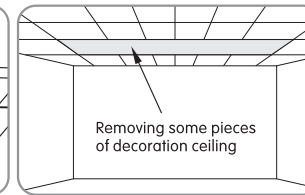

Diagram 2

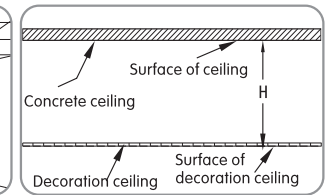

Diagram 3

2. Please measure the height between surfaces of concrete ceiling and decoration ceiling (diagram 3) for optional installation modes:

A. If the "H" is about 120mm, please install the screen directly onto concrete ceiling, see diagram 4;
B. If the "H" is above 120mm, optional accessories including the hook and extended bolt are needed to complete installation, see diagram 5.

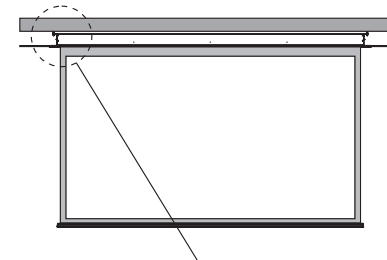

Diagram 4 For installation to low ceiling

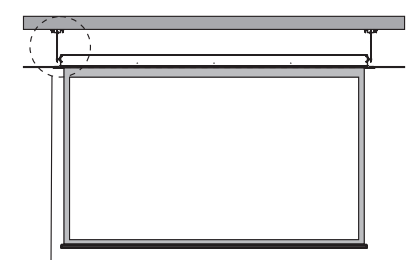
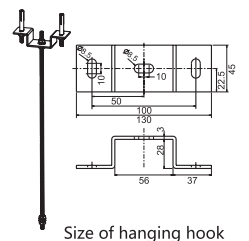
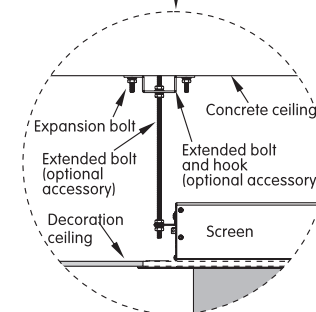
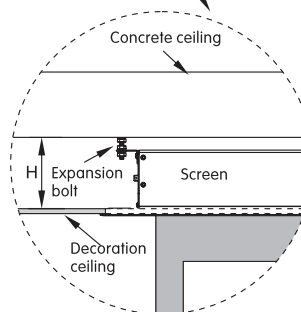

Diagram 5 For installation to high ceiling



Size of hanging hook

Installation Instruction

Note: Please make sure the concrete ceiling is strong enough to be bear the weight of 50kg or above before starting installation in order to avoid any damage on product or property lost and casualty due to insufficient bearing.

Note: Installation of the product must be completed by qualified technician(s), or it would result in damage, property lost and casualty.

3. According to the installation modes, please drill holes on concrete ceiling and fix expansion bolt (included in fitting pack) in model of M8*80 or longer one into the holes, see diagram 6 and 8; for high ceiling installation, hooks and extended bolts are needed to work with M8*60 expansion blot (optional accessories), see diagram 7 and 9;

Note: The center distance of two holes drilled for suspending purpose should strictly follow the actual dimension of the product, or the installation is not likely to be done; the distance from the two holes drilled for suspending purpose to both ends of the decoration ceiling should be the same. The suspending (installation) distance equals overall length of screen minus 80mm, please refer to the specification diagram for details.

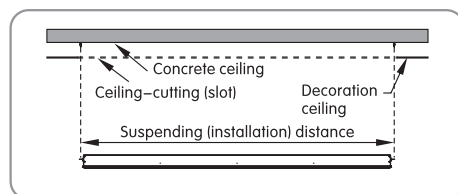

Diagram 6 Use screws for installation to low ceiling

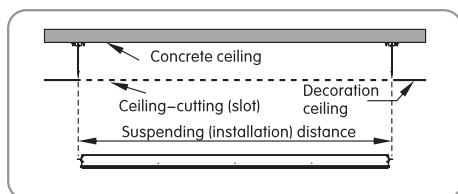

Diagram 7 Use hook for installation to high ceiling

4. Both of the installation modes need to put the extra M8 nuts and gaskets for adjustment on the height of installation, see diagram 8-9;

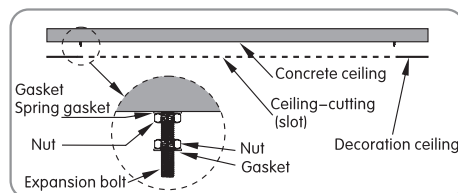

Diagram 8 Use screen for installation to low ceiling

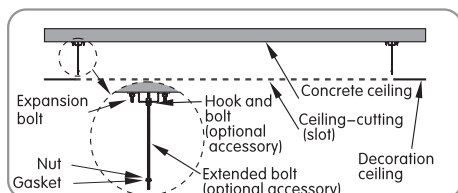

Diagram 9 Use hook for installation to high ceiling

5. Choose the sets of mounting holes for fixture according to the installation mode selected. Please use the M5*10 screws included in fitting pack to fix the screen. If the extended bolts are not needed in installation, please choose the first set of mounting holes for fixture, see diagram 10; for installation to high ceiling where extended bolts are applied, please choose the second mounting holes according to installation environment or apply the mounting brackets upside down for installation purpose, see diagram 11. The third mounting holes are only applied to ordinary motorized screen, while the intelligent motorized screen is not applicable due to the PCBA attached on the left end cap, see diagram 12.

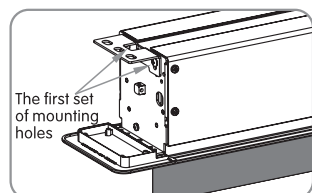

Diagram 10

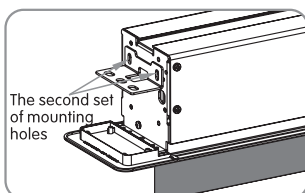

Diagram 11

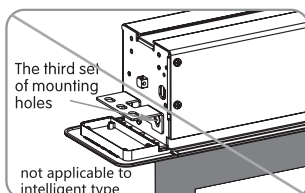

Diagram 12

Installation Instruction

6. Lift the screen and put it into the mounting holes pre-drilled. The fixing holes on two ends of installation plate should align to the expansion bolts or extended bolts on ceiling, see diagram 13-14.

Note: This step must be completed by two installers who should hold two ends of screen respectively when installation.

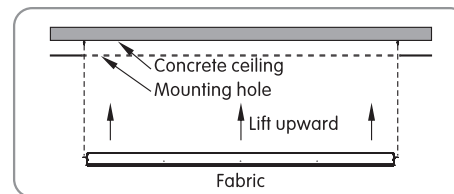

Diagram 13

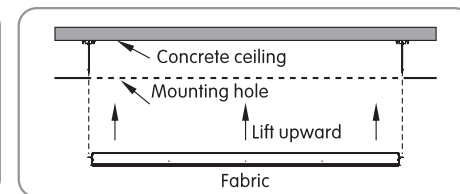

Diagram 14

7. Please put gasket, spring gasket and nut through the bolt, twist the nut for several rounds but not fasten it (diagram 15-16), and adjust the position of the nuts above and below the installation plate to get the front and back part of decoration board close enough to the decoration ceiling. Then please fasten the nut below the installation plate, see diagram 15-18.

Note: The screen must be operated in level condition. Please make necessary adjustment for screen to be horizontal when installing, or it would be likely to do damage to the screen.

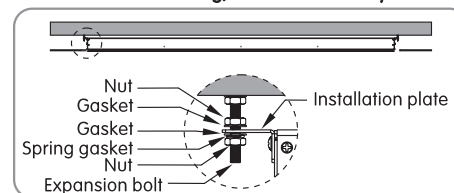

Diagram 15

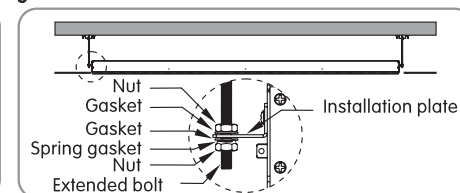

Diagram 16

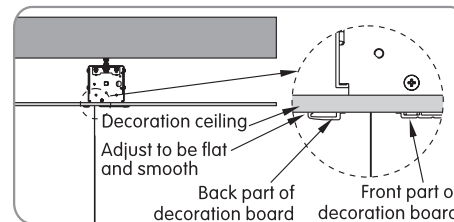

Diagram 17

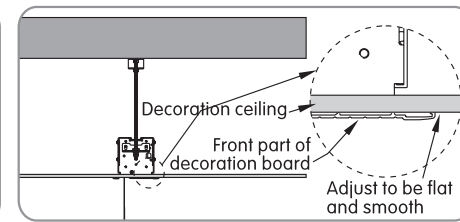

Diagram 18

Warning: Any installation of the screen related to electrical operation must be done by qualified electrician, or it is likely to damage the product or property lost and casualty.

Note: Before connecting the products to power supply, please make sure the put-in voltage is in conformity with rated voltage of the product. It is recommended that supply power should be 2 times or above as much as the rated power of the product. Any improper power supply would lead to abnormal performance or even spoil the product.

8. Please fix the inline switch or external remote control receiving box where it is convenient to get access to. Then plug in the socket to connect to power supply.

9. Operate the screen to complete retraction and extension for once or twice to see if it is working normally before moving to next step of installation.